



Glossary of common terms

About this guide

This glossary is intended to assist anyone who would like to understand common terms used in the heavy vehicle industry. The terms and definitions provide a single common reference point.

Entries are organised alphabetically and, where relevant, the source of the definition is referenced. A list of acronyms is provided in Section 2, while the detailed list of terms can be found in Section 3.

Terms used in this glossary do not supersede or replace those in the Heavy Vehicle National Law (HVNL) but are meant to help users develop a common understanding of terminology particular to the heavy vehicle industry. In developing this Glossary, the following references have been used:

Heavy Vehicle National Law (HVNL)
Heavy Vehicle National Regulations
Austroads Glossary of Terms¹.

Definitions for which a source is not provided have been drafted by the NHVR for the sole purpose of this Glossary. These definitions have been drafted using existing policy documents and guidelines issued by the NHVR.

For more information

This document will be regularly reviewed and your feedback and comments are welcomed.

If you are not sure about the context or meaning of a term in this guide, or want to comment, email us at info@nhvr.gov.au and note “NHVR Glossary of common terms” in the subject line.

Any information or comment you provide will only be used for developing future NHVR publications. Your contact details will only be used for these purposes and will not be disclosed to any third party without your consent, unless required to do so by law.

Contact: National Heavy Vehicle Regulator

Level 3, 76 Skyring Tce

Gasworks

Newstead QLD 4006

P: 1300 MYNHVR (1300 696 487)

E: info@nhvr.gov.au

W: www.nhvr.gov.au

Acronyms

© National Heavy Vehicle Regulator (2016)

<http://creativecommons.org/licenses/by-sa/3.0/au>

This work is licensed under a Creative Commons Attribution-ShareAlike 3.0 Australia Licence. To attribute this material, cite National Heavy Vehicle Regulator “NHVR Glossary of common terms”





Although every attempt has been made to ensure the accuracy of the content of this Glossary, it should not be relied upon as legal advice

¹ Austroads Glossary of Terms – Fifth Edition, July 2014, Publication No: AP-C87-14, Austroads, Sydney.

ABN	Australian Business Number
ABS	Antilock Braking System; or Australian Bureau of Statistics
ACC	Active Cruise Control
ACN	Australian Company Number
ADR	Australian Design Rule
AFM	Advanced Fatigue Management
AMVCB	Australian Motor Vehicle Certification Board
ANZPAA	Australian New Zealand Policing Advisory Agency
ARBN	Australian Registered Business Number
ASR	Auto Slip Regulation (same as ATC – Auto Traction Control)
ATC	All Terrain Crane; or Auto Traction Control (same as ASR)
ATDAN	Australian Transport Data Action Network
ATM	Aggregate Trailer Mass
AVE	Approved Vehicle Examiner
BFM	Basic Fatigue Management
CAN	Compliance Audit Notification
CAN Bus	Controller Area Network Bus (a means of electronic communication, not a vehicle)
CARs	Corrective Action Requests
CML	Concessional Mass Limits
CoR	Chain of Responsibility
CSV	Comma-Separated Values (computer file)
CTPI	Compulsory Third Party Insurance
CWD	Container Weight Declaration
DIER	(formerly) Department of Infrastructure, Energy and Resources (TAS), now Department of State Growth
DMA	Dimension Measurement Adjustment
DPTI	Department of Planning, Transport and Infrastructure (SA)
DSS	Dynamic Stability System (same as ESP and ESC)
EBS	Electronic Braking System (same as ECBS)
ECBS	Electronic Controlled Braking System (same as EBS)
ESC	Electronic Stability Control (same as DSS and ESP)
ESP	Electronic Stability Program (same as DSS and ESC)



EWD	Electronic Work Diary
FIRS	Federal Interstate Registration Scheme (see www.infrastructure.gov.au/roads/motor/firs/)
G2G	Government to Government
GAV	General Access Vehicle
GCM	Gross Combination Mass
GCW	Ground Contact Width
GIS	Geographic Information System
GML	General Mass Limits
GTM	Gross Trailer Mass
GVM	Gross Vehicle Mass
HML	Higher Mass Limits
HV(FM)NR	<i>Heavy Vehicle (Fatigue Management) National Regulation</i>
HV(G)NR	<i>Heavy Vehicle (General) National Regulation</i>
HV(MDL)NR	<i>Heavy Vehicle (Mass, Dimension and Loading) National Regulation</i>
HV(VS)NR	<i>Heavy Vehicle (Vehicle Standards) National Regulation</i>
HVNL	<i>Heavy Vehicle National Law</i>
IAP	Intelligent Access Program
ICT	Information and Communication Technology
IGA	Intergovernmental Agreement
IPS	In-principal support
KPI	Key Performance Indicator
LGA	Local Government Association
LPI	Local Productivity Initiative
MA	Measurement Adjustment
MDL	Mass, Dimension and Loading; or Mass, Distance, Location
MMA	Mass Measurement Adjustment
MRWA	Main Roads Western Australia (WA)
MVSA	<i>Motor Vehicle Standards Act 1989</i> of the Commonwealth
NDS	National Data Strategy
NEVDIS	National Exchange of Vehicle and Driver Information System
NHVAS	National Heavy Vehicle Accreditation Scheme

NHVIM	National Heavy Vehicle Inspection Manual
NHVR	National Heavy Vehicle Regulator
NTC	National Transport Commission
OSOM	Oversize, Overmass
PBS	Performance Based Standards
RAV	Restricted Access Vehicle
RCN	Regulator Customer Number
RCS	Risk Classification System
RMS	Roads and Maritime Services (NSW), formally Roads and Traffic Authority (NSW)
RPL	Recognition of Prior Learning
RSC	Roll Stability Control (same as RSP and RSS)
RSP	Roll Stability Program (same as RSC and RSS)
RSS	Roll Stability System (same as RSC and RSP)
RTO	Registered Training Organisation
SPV	Special Purpose Vehicle
SSD	Stopping Sight Distance
TEBS	Trailer Electronic Braking System
TMR	Department of Transport and Main Roads (QLD)
VicRoads	Roads Corporation of Victoria
VIN	Vehicle Identification Number
VS6	Vehicle Standards Bulletin 6: National Code of Practice – Heavy Vehicle Modifications
VS11	Vehicle Standards Bulletin 11: Certification of Road Friendly Suspensions
VS12	Vehicle Standards Bulletin 12: Rear Marking Plates

Acronym/ term	Description	Source
A		
'A' dolly	See converter dolly .	
'A' type coupling	A drawbar-based coupling type. This coupling type does not transfer roll or, generally speaking, load between the vehicle units.	
A-double	A prime mover towing a semitrailer towing another semitrailer connected by a converter dolly.	
		
A-triple	A prime mover towing three semitrailers. The second and third semitrailers are each connected by a converter dolly.	
		
AB-triple	A prime mover towing three semitrailers. The second semitrailer is connected by a converter dolly and the third trailer is connected by a fifth wheel located towards the rear of the preceding semitrailer. Can also be described as a semitrailer towing a B-double using a converter dolly.	
		
AAB-Quad	A prime mover towing four semitrailers. The second and third semitrailers are connected by a converter dolly and the fourth semitrailer is connected by a fifth wheel located towards the rear of the preceding semitrailer. Can also be described as an A-double towing a B-double using a converter dolly.	
		
ABB-Quad	A prime mover towing four semitrailers. The third and fourth semitrailers are connected by a fifth wheel located towards the rear of the preceding semitrailer and the second semitrailer is connected by a converter dolly. Can also be described as a semitrailer towing a B-triple using a converter dolly.	
		

Accreditation certificate	If the Regulator grants a heavy vehicle accreditation under the HVNL to an operator, the Regulator must give the operator an accreditation certificate that states: <ul style="list-style-type: none"> the name of the operator who has been granted the accreditation; the number identifying the accreditation; any conditions imposed on the accreditation by the Regulator; for an AFM accreditation, the maximum work times and minimum rest times that apply to drivers of fatigue-regulated heavy vehicles operating under the accreditation; the period for which the accreditation applies. 	HVNL
Accreditation label (NHVAS)	Under mass management or maintenance management accreditation, each nominated vehicle must display an accreditation label.	HVNL
Audit Completion Notification (ACN)	Provides notification to the Regulator that the audit has been conducted, who conducted the audit, where and on what date. It includes a summary of the result of the audit with confirmation that the operator meets the standards for the accreditation module, including any CARs arising from the audit and the date on which they will be closed out by the operator. The ACN does not contain a detailed report of the audit; this information is documented in the NHVAS Audit Summary Report.	
Advanced fatigue management (AFM) system	A management system that meets the BFM standard and applies additional standards for driver health, work environment, management practices and operational limits.	HVNL
Aggregate trailer mass (ATM)	Of a heavy trailer, means the total maximum mass of the trailer, as stated by the manufacturer together with its load and the mass imposed on the towing vehicle by the trailer when the towing vehicle and trailer are on a horizontal surface.	HVNL
Agricultural combination	A combination consisting of at least one agricultural vehicle. Glossary Note: This does not include the carrying of an agricultural vehicle as an indivisible load upon a non-agricultural vehicle or combination.	HV(MDL) NR
Agricultural implement	A vehicle without its own automotive power, built to perform agricultural tasks, and includes an agricultural trailer. Examples: <ul style="list-style-type: none"> Auger Conveyor Field bin Harvester front Irrigating equipment or machinery 	HVNL

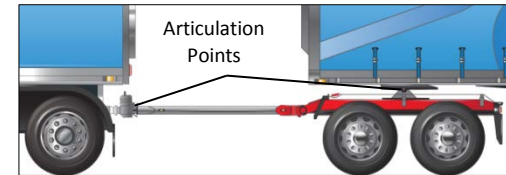

Agricultural machine	A vehicle with its own automotive power, built to perform agricultural tasks. Examples: Harvester	HVNL
	 	
Agricultural task	Examples of an agricultural task— <ul style="list-style-type: none"> • Cultivating land • Growing and harvesting crops • Rearing livestock 	HVNL
Agricultural trailer	A trailer that is designed to carry a load and used exclusively to perform agricultural tasks, but does not include a semitrailer.	HVNL
Agricultural vehicle	An agricultural implement or agricultural machine.	HVNL
All-terrain mobile crane	An SPV that has all of the following features and requirements: <ul style="list-style-type: none"> • is a mobile crane; and • has two tyres per axle; and • has at least 50% of its axles steerable; and • is not a truck mounted SPV; and • has on road and off road capability; and • has separate driving and crane operating compartments. 	National class 1 SPV notice
		
Application	A means to apply for Regulator services through a structured process utilising prescribed forms and formats. May incur an application fee and subsequent costs may be associated. Examples are NHVAS and permit requests. Note: Not be confused with a software application.	
Approval	This is used as a catch-all term for approvals made by the Regulator or other authorising bodies. Approvals include all permits, notices, enrolments and registrations.	
Approved form	A form approved by the Regulator under the HVNL and used to make applications or provide notifications to the Regulator e.g. for amendment or cancellation of an exemption, or used to provide certifications, notices etc. issued by or on behalf of the Regulator.	

Approved sleeper berth	1. for a fatigue-regulated heavy vehicle other than a fatigue-regulated bus, a driver's sleeper berth that complies with ADR 42 and is able to be used by the driver when resting; or 2. for a fatigue-regulated bus, a driver's sleeper berth that: <ul style="list-style-type: none"> – complies with a standard for sleeper berths that is approved by the responsible Ministers under HVNL s654; and – is able to be used by the driver when resting 	HVNL
Approved Vehicle Examiner (AVE)	A person who is authorised under the HVNL to carry out a particular function based on their accreditation or approval from a jurisdiction to carry out the same or equivalent function. Note: Currently, AVEs are only authorised under the HVNL to approve modifications in accordance with section 86.	
Articulated bus	A bus with two or more rigid sections connected to one another in a way that allows— <ul style="list-style-type: none"> – Passenger access between the sections; and – Rotary movement between the sections. 	HVNL
		
Assessed dimension	The measured dimension of the vehicle minus the appropriate DMA.	
Assessed mass	The measured mass of the vehicle minus the appropriate MMA.	
Assigned dimension	Any prescribed dimension limit under the HVNL, the national Regulations or as per a notice or permit.	
Assigned mass	Any prescribed mass limit under the HVNL, the national Regulations or as per a notice or permit.	
Articulation point	The point(s) from which a vehicle will articulate during a turning manoeuvre. The legal definition for 'front articulation point' can be found in section 3 of the HV(MDL)NR.	
		
Audit Matrix (NHVAS)	A primary on-site audit tool that provides a template for the auditor to systematically record evidence about the operator's compliance with the accreditation standards. There is a separate Audit Matrix for each of the three NHVAS accreditation modules.	

Australian design rule (ADR)	A national standard under section 7 of the <i>Motor Vehicle Standards Act 1989</i> of the Commonwealth.	HVNL
Authorised officer	<ol style="list-style-type: none"> 1. a police officer declared by a law of a participating jurisdiction to be an authorised officer for the purposes of this Law; or 2. a person who holds office under this Law as an authorised officer 	HVNL
Authority	<p>A form or expression of delegated power. In the context of the HVNL, the term has a number of definitions, for instance 'mass and dimension' authority is the highest order definition in the HVNL Part 4 encompassing both:</p> <ul style="list-style-type: none"> • Mass or dimension exemptions (notices and permits); and • Class 2 heavy vehicle authorisations (notices and permits). • Also commonly used in the context of road authorities, such as VicRoads or RMS. 	
Axle	One or more shafts positioned in a line across a vehicle, on which one or more wheels intended to support the vehicle turn.	HVNL
Axle group	A tandem axle group, twinsteer axle group, tri-axle group or quad-axle group.	HVNL
B		
Base, of the driver of a heavy vehicle	<p>Also referred to as "home base" or "driver's base".</p> <p>In relation to particular work -</p> <ul style="list-style-type: none"> • is the place from which the driver normally does the work, but • is, for the purposes of Chapter 6, the garage address of the vehicle if: <ul style="list-style-type: none"> • the vehicle is a fatigue-regulated heavy vehicle; and • the driver is required under Part 6.4, in relation to that particular work, to keep a work diary and to record the location of the driver's base in the work diary, and has not done so. <p>Note: The driver of a fatigue-regulated heavy vehicle may not be required under Part 6.4, in relation to particular work, to keep a work diary and to record the location of the driver's base in the work diary, if, for example;</p> <ul style="list-style-type: none"> • the driver is undertaking 100 km work under standard hours • the driver is working under a work diary exemption <p>For a driver who is a self-employed driver and an employed driver at different times, the driver may have one base as a self-employed driver under paragraph 1 and another base as an employed driver under that paragraph.</p> <p>For a driver who has two or more employers, the driver may have a different base in relation to each employer under paragraph 1.</p>	HVNL

B-double A combination consisting of a prime mover towing two semitrailers, with the first semitrailer being attached directly to the prime mover by a fifth wheel coupling and the second semitrailer being mounted on the rear of the first semitrailer by a fifth wheel coupling on the first semitrailer. HVNL



B-triple A prime mover towing three semitrailers. The second and third semitrailers are connected by a fifth wheel located towards the rear of the preceding semitrailer.



BA-triple A prime mover towing three semitrailers. The second semitrailer is connected by a fifth wheel located towards the rear of the preceding semitrailer and the third semitrailer is connected by a converter dolly. Can also be described as a B-double towing a semitrailer using a converter dolly.



BAA-Quad A prime mover towing four semitrailers. The second semitrailer is connected by a fifth wheel located towards the rear of the preceding semitrailer and the third and fourth semitrailers are connected by a converter dolly. Can also be described as a B-double towing an A-double using a converter dolly.



BAB-Quad A prime mover towing four semitrailers. The second and fourth semitrailers are connected by a fifth wheel located towards the rear of the preceding semitrailer and the third semitrailer is connected by a converter dolly. Can also be described as a B-double towing a B-double using a converter dolly.



'B' type coupling A fifth wheel connection coupling. This coupling type transfers roll and load between the vehicle units. Also see [fifth wheel coupling](#).

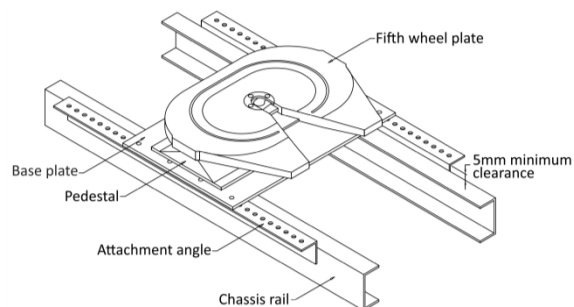

Basic fatigue management (BFM) system A management system demonstrating that driver fatigue is appropriately controlled via schedules, driver rostering, fitness for duty, management monitoring and controls. HVNL

Bogie axle group See [tandem axle group](#).

Bus A heavy motor vehicle built or fitted to carry more than nine adults, including the driver. HVNL



Business day A day that is not—
 • a Saturday or Sunday; or
 • a public holiday, special holiday or bank holiday in the place in which any relevant act is to be or may be done. HVNL

C

CAN Bus This is a means of electronic communication between devices, commonly used in heavy vehicles. A CAN Bus (for controller area network) is a vehicle bus standard designed to allow microcontrollers and devices to communicate with each other within a vehicle without a host computer.

Carrier-mounted SPV A heavy motor vehicle that is an SPV where the axles, chassis frame and main equipment are built as an integral vehicle unit, and which cannot be divided without extreme effort, expense or risk of damage to it. A carrier-mounted SPV is not a truck-mounted SPV. Most mobile cranes including all-terrain mobile cranes and truck cranes are carrier-mounted SPVs. National class 1 SPV notice

Chain of Responsibility (CoR)

Chain of Responsibility is similar to the legal concept of 'duty of care' that underpins Occupational Health and Safety (OHS) law. This approach has long been used by the courts to impose liability in negligence and damages claims.

Under CoR, complying with transport law is a shared responsibility and all parties in the road transport supply chain are responsible for preventing breaches. This approach recognises the effects of the actions, inactions and demands of off-the-road parties in the transport chain.

Anybody – not just the driver – who has control over the transport task can be held responsible for breaches of road laws and may be legally liable.

See also [party in the chain of responsibility](#).

Class 1 vehicle A heavy vehicle is a Class 1 heavy vehicle if it, together with its load, does not comply with a prescribed mass requirement or prescribed dimension requirement applying to it, and— HVNL

1. it is a special purpose vehicle; or
2. it is an agricultural vehicle other than an agricultural trailer; or
3. it—
 - is a heavy vehicle carrying, or designed for the purpose of carrying, a large indivisible item, including, for example, a combination including a low loader; but
 - is not a road train or B-double, or carrying a freight container designed for multi-modal transport.



An agricultural trailer is a Class 1 heavy vehicle, irrespective of whether it, together with its load, does or does not comply with a prescribed mass requirement or prescribed dimension requirement applying to it.

Class 1 notice A notice issued under s117 of the HVNL for Class 1 vehicles.

Class 1 permit A permit issued under s122 of the HVNL for a Class 1 vehicle(s).

Class 2 vehicle A heavy vehicle is a Class 2 heavy vehicle if it is a PBS vehicle or it — HVNL

- complies with the prescribed mass requirements and prescribed dimension requirements applying to it; and
- is
 - a B-double
 - a road train
 - a bus, other than an articulated bus, that is longer than 12.5 metres
 - a combination designed and built to carry vehicles on 1 deck that, together with its load is longer than 19.0 metres or higher than 4.3 metres or
 - a motor vehicle, or a combination, that is higher than 4.3 metres and is built to carry cattle, sheep, pigs or horses

Class 2 notice	A notice issued under s138 of the HVNL for Class 2 vehicles.	
Class 2 permit	A permit issued under s143 of the HVNL for a Class 2 vehicle(s).	
Class 3 vehicle	A heavy vehicle is a Class 3 heavy vehicle if— <ul style="list-style-type: none"> it, together with its load, does not comply with a prescribed mass requirement or prescribed dimension requirement applying to it; and it is not a Class 1 heavy vehicle. 	HVNL
Class 3 notice	A notice issued under s117 of the HVNL for Class 3 vehicles.	
Class 3 permit	A permit issued under s122 of the HVNL for a Class 3 vehicle(s).	
Combination	A group of vehicles consisting of a motor vehicle such as a prime mover or rigid truck towing one or more other vehicle units such as a semitrailer or trailer.	
Combine harvester	An agricultural vehicle that simultaneously performs operations of reaping, threshing and winnowing of grain crops.	HV(MDL) NR
		
Commonwealth gazette notice	A notice published in the Commonwealth Gazette. In the context of this glossary and other documents which reference it, a notice is a Commonwealth Gazette notice unless otherwise stated e.g. notices gazetted by non-Commonwealth jurisdictions.	
Component vehicle	The towing vehicle or another vehicle in the combination, for instance a truck, prime mover, trailer or dolly.	
Compliance Audits (NHVAS)	An audit used to confirm that the operator's management system is in place, that it continues to adhere to the relevant NHVAS business rules and standards, and that management and staff are aware of, and comply with, the relevant policies and procedures. Entry Audit is the first audit undertaken of the operator's management system and verifies that the operator's policies, procedures and record keeping systems will comply with the relevant accreditation standards Initial Compliance Audit is conducted between the 6 to 7 months after accreditation is granted to confirm that the operator's management system is in place, that it continues to adhere Compliance Audits are conducted within a period 9 months prior to the expiry of the accreditation period and confirms that the management system for which accreditation was granted is functioning effectively within the operator's business.	
Compliance Audit Notification (CAN)	Form submitted by the operator confirming that a compliance audit has been arranged with an NHVAS Approved Auditor and is approved by the NHVR. This form must be submitted to the NHVR at least 28 days prior to the date of the audit.	
Concessional mass limits (CML)	Concessional mass limits are mass exceptions that apply as an exception to the general mass limits. CML applies to certain heavy vehicles and the operator of the CML heavy vehicle must hold NHVAS Mass Management Accreditation and the vehicle must be nominated.	HV(MDL) NR
Concrete pump	A vehicle with a component that can be used to transfer liquid concrete by pumping. 	HVNL
Condition (Access)	A condition of access provided by a road manager or the Regulator (in certain situations). This is a condition directed at — <ul style="list-style-type: none"> mitigating or avoiding significant risk to public safety; or managing road infrastructure; or managing public amenity, including, for example, managing the impact of noise, emissions and traffic congestion caused by vehicle use of roads or road-related areas. The condition may be attached to a route or road segment e.g. conditions can include speed and direction specifications, and curfews. Conditions may also be added by a road manager for the specific task i.e. related to a permit. See also road condition , travel condition and vehicle condition .	HVNL
Condition (NHVAS)	A heavy vehicle accreditation granted under the HVNL is subject to the condition that the operator who holds the accreditation must comply with the relevant standards and business rules. A heavy vehicle accreditation may be subject to any other conditions the Regulator considers appropriate, for example— <ul style="list-style-type: none"> a named person cannot operate under the operator's accreditation for a stated period; and a named employee or associate of the operator cannot be involved in the operator's relevant management system at all or for a stated period; and requirement for additional records to be kept, and audits to be performed, to ensure practices (for example, driver fatigue management practices) are followed. 	HVNL

Corrective Action Requests (CARs)	A non-conformance of the operator’s management system to the NHVAS business rules and standards identified by the NHVAS Approved Auditor. The non-conformance identified explains to the operator the failure within their management system.	
--	---	--

Consignee	A consignee of goods means a person who – <ul style="list-style-type: none"> • has consented to being, and is, named or otherwise identified as the intended consignee of the goods in the transport documentation relating to the road transport of the goods; or • actually receives the goods after completion of their road transport; but • does not include a person who merely unloads the goods. 	HVNL
------------------	---	------

Container weight declaration	A written declaration, whether contained in one or more documents, stating or purporting to state the weight of a freight container and its contents e.g. an email, a placard fixed to the container.	HVNL
-------------------------------------	---	------

Converter dolly	Means a pig trailer with a fifth wheel coupling designed to convert a semitrailer into a dog trailer.	HVNL
------------------------	---	------



Coupling	A device used to couple a vehicle in a combination to the vehicle in front of it.	HVNL
-----------------	---	------

Customer	A customer denotes a person, organisation or entity who transacts with the Regulator.	
-----------------	---	--

D

Defective heavy vehicle	A heavy vehicle that- <ul style="list-style-type: none"> • contravenes the heavy vehicle standards; or • has a part that: • does not perform its intended function; or • has deteriorated to an extent that it cannot be reasonably relied on to perform its intended function. 	HVNL
--------------------------------	---	------

Dog trailer	A trailer (including a trailer consisting of a semitrailer and converter dolly) that has— <ul style="list-style-type: none"> • one axle group or a single axle at the front that is being steered by connection to a towing vehicle by a drawbar; and • one axle group or a single axle at the rear. 	HV(VS)NR
--------------------	--	----------



Drawbar	That part of a trailer (other than a semitrailer) that connects the trailer body to a coupling for towing purposes.	HV(VS)NR
----------------	---	----------

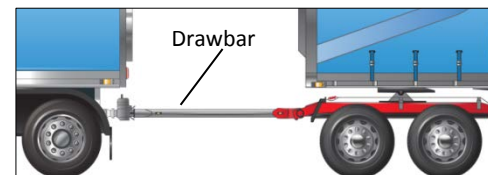

E

Emergency service	An entity that has a statutory responsibility to respond to an emergency and includes the following- <ul style="list-style-type: none"> • an ambulance service; • a fire brigade, including a volunteer fire brigade; • a police force or police service; • a disaster or emergency organisation of the Commonwealth or a state or territory. 	HVNL
--------------------------	---	------

Escort vehicle	A pilot vehicle that is driven by a police officer or another person authorised to direct traffic under an Australian road law. (See also Pilot vehicle).	HVNL
-----------------------	--	------

Exemption	A legal instrument used to provide alternative or non-compliance with a law, regulation or standard. For example, a vehicle standards exemption, a fatigue-related exemption (e.g. a work/rest hours exemption), or an access-related exemption. An exemption can be provided by notice or permit.	
------------------	--	--

F

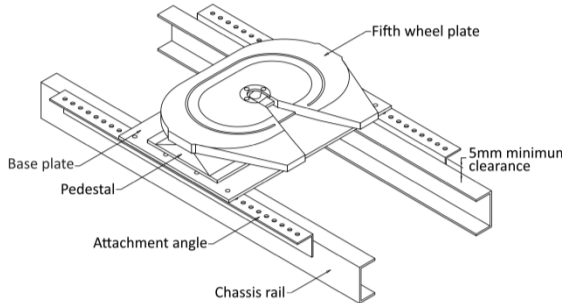
Fatigue-regulated heavy vehicle	<p>A heavy vehicle that is any of the following:</p> <ul style="list-style-type: none"> • a motor vehicle with a GVM of more than 12 tonnes; • a combination with a GVM of more than 12 tonnes; • a fatigue-regulated bus. <p>However, subject to (3) a heavy vehicle is not a fatigue-related heavy vehicle if it is any of the following:</p> <ul style="list-style-type: none"> • a motor vehicle that— • is built, or has been modified, to operate primarily as a machine or implement off-road, on a road-related area, or on an area of road that is under construction; and • is not capable of carrying goods or passengers by road; <p>For example, an agricultural machine, backhoe, bulldozer, excavator, forklift, front-end loader, grader, motor vehicle registered under an Australian road law as a special purpose vehicle (type p).</p> <ul style="list-style-type: none"> • a motorhome. <p>A truck, or a combination including a truck, that has a machine or implement attached to it is a fatigue-regulated heavy vehicle:</p> <ul style="list-style-type: none"> • if the GVM of the truck or combination with the attached machine or implement is more than 12t; and • whether or not the truck or combination has been built or modified primarily to operate as a machine or implement off-road, on a road-related area, or on an area of road that is under construction. <p>Example for the purposes of subsection (3)—a truck to which a crane or drilling rig is attached</p> <p>A motorhome is deemed to be:</p> <ul style="list-style-type: none"> • a rigid or articulated motor vehicle or combination that is built, or has been modified, primarily for residential purposes; and • does not include a motor vehicle that is merely a motor vehicle constructed with a sleeper berth. <p>For the purposes of this section, the GVM of a combination is the total of the GVMs of the vehicles in the combination.</p>	HVNL
Fatigue Management System (NHVAS)	<p>A system used to manage fatigue. The Regulator provides accreditation under two fatigue management systems.</p> <p>See Basic Fatigue Management (BFM) and Advanced Fatigue Management (AFM).</p>	
Fifth wheel coupling	<p>A device (other than an upper rotating element and a kingpin) used with a prime mover, semitrailer or converter dolly to—</p> <ul style="list-style-type: none"> • permit quick coupling and uncoupling; and • provide for articulation. 	HVNL
		
Front under-run protection (FUP)	<p>A device or barrier installed at the front of a heavy vehicle with the purpose of preventing other vehicles from being pushed underneath the front of the heavy vehicle in the event of a collision.</p>	
G		
Garage address	<ol style="list-style-type: none"> 1. for a heavy vehicle normally kept at a depot when not in use, the principal depot of the vehicle; or 2. for a heavy vehicle not normally kept at a depot when not in use, the address of the place of business or residence at which the vehicle is normally kept when not in use. 	HVNL
Gazette notice	<p>A legal instrument that provides the Regulator with the ability to issue information, authorisations or exemptions, that apply to a certain class(es) of heavy vehicle or persons and will generally include conditions.</p>	
General access vehicle (GAV)	<p>In terms of heavy vehicles on Australian roads, these are vehicles which do not require a permit or notice to run on the road networks. These vehicles have as-of-right access to the network unless otherwise sign posted.</p>	
General mass limits (GML)	<p>The heavy vehicle general axle mass limits prescribed in the HVNL that apply to public roads in Australia unless otherwise limited by load restriction signs.</p>	
Grouped axle (as opposed to axle group)	<p>A configuration of more than four axles fitted to a trailer that is not a dog trailer.</p>	

Gross combination mass (GCM)	Means the total maximum loaded mass of a vehicle and any vehicles it may lawfully tow at any given time— <ul style="list-style-type: none"> If the Regulator has, under section 56, specified the total maximum loaded mass of the motor vehicle and any vehicles it may lawfully tow at any given time – specified by the Regulator under that section*; or Otherwise – stated by the motor vehicle’s manufacturer. <p>*Note: HVNL Chapter 2, which includes section 56, has not yet commenced and as such jurisdictional definitions may also apply.</p>	HVNL
Gross trailer mass (GTM)	The mass transmitted to the ground by the axles of the trailer when it is loaded to its ATM and connected to a towing vehicle.	HV(VS)NR
Gross vehicle mass (GVM)	Of a vehicle, means the maximum loaded mass of the vehicle— <ul style="list-style-type: none"> If the Regulator has specified the vehicle’s maximum loaded mass under section 57—specified by the Regulator under that section*; or Otherwise—stated by the vehicle’s manufacturer. <p>*Note: HVNL Chapter 2, which includes section 57, has not yet commenced and as such jurisdictional definitions may also apply.</p>	HVNL
Ground clearance	The minimum distance between the ground and the vehicle’s underside, other than its tyres, wheels, wheel hubs, brake backing plates, flexible mudguards and mudflaps.	HV(MDL) NR
Ground contact width (GCW)	In relation to an axle, the distance between the outermost point of ground contact of the outside tyres on each end of the axle. In relation to an axle group, the greatest ground contact width of all the axles in the group.	National class 1 SPV notice
<p style="text-align: center;">Ground contact width (GCW)</p>		
H		
Hauling unit	A motor vehicle that forms part of a combination, but does not include a prime mover.	HVNL
Heavy combination	A combination that is a heavy vehicle.	HVNL
Heavy motor vehicle	A motor vehicle that is a heavy vehicle.	HVNL

Heavy vehicle	For the purposes of the HVNL a vehicle is a heavy vehicle if it has a GVM or ATM of more than 4.5 tonnes Also, for the purposes of this Law other than in relation to registration under this Law, a combination that includes a vehicle with a GVM or ATM of more than 4.5 tonnes is a heavy vehicle. Rolling stock is not a heavy vehicle under this Law. Refer to the definitions of Class 1, 2, and 3 heavy vehicles for more detailed classifications.	HVNL
Heavy Vehicle National Law (HVNL)	An Australian law with the purpose of regulating the heavy vehicle industry including registration, driver fatigue, vehicle standards, mass dimension and loading, compliance and enforcement and access.	
Higher mass limits (HML)	A mass exception under the HVNL which allows higher mass limits on approved routes for particular vehicles or vehicle combinations dependent on other conditions being met (e.g. IAP and/or road friendly suspension may need to be fitted to the vehicle).	
I		
Induction Letter (BFM / AFM)	A document, signed by the operator of the vehicle who holds the accreditation, stating that the driver— <ul style="list-style-type: none"> is operating under the operator’s BFM accreditation or AFM accreditation; and has been inducted into the operator’s relevant management system; and meets the requirements relating to drivers operating under the operator’s BFM accreditation or AFM accreditation. 	
Information and communication technology (ICT)	Technologies used for accessing, gathering, manipulating, presenting or communicating information. ICT replaces IT (Information Technology) as a general descriptor of services, products and organisations.	
Intelligent Access Program (IAP)	IAP is a program to allow heavy vehicles to have access, or improved access, to the road network in return for monitoring, by an intelligent transport system, of their compliance with stated access conditions. (Also see http://www.tca.gov.au)	
Interception report book	Operators accredited for mass management accreditation and maintenance management vehicle must keep an interception report book in each vehicle. When intercepted by a police officer or authorised officer, the driver must present the interception report book. Failure to produce an interception report book may result in sanctions against the accredited operator. The officer will record details of the interception, including any non-conformance, or record that compliance has been met.	

Inter-governmental Agreement (IGA)	A signed agreement between the Commonwealth of Australia and the states and territories, currently excluding Western Australia, on the Heavy Vehicle Regulatory Reform.	
In-principle support (IPS)	Written advice provided by the Regulator to the importer, manufacturer or operator of a non-standard heavy vehicle that indicates that the vehicle will be eligible for road use. An IPS is issued by the Regulator, in consultation with state and territory registration authorities.	
J		
Jurisdiction	State, territory, Commonwealth or local government entity.	
K		
L		
Large indivisible item	A large item that cannot— <ul style="list-style-type: none"> – be divided without extreme effort, expense or risk of damage to it; and – be carried on any vehicle or combination without contravening a mass requirement or dimension requirement. 	HVNL
Lead trailer	A semitrailer with a fifth-wheel assembly mounted over the rear axle group, the first trailer in a B-double or other B-coupled combination (e.g. B-triple).	
		
Light vehicle	A vehicle that is not a heavy vehicle.	
Load	Load, of a heavy vehicle or in a heavy vehicle, means— <ul style="list-style-type: none"> • all the goods, passengers, drivers and other persons in the vehicle; and • all fuel, water, lubricants and readily removable equipment carried in the vehicle and required for its normal use; and • personal items used by the vehicle's driver or someone else necessary for the normal use of the vehicle; and • anything that is normally removed from the vehicle when not in use. 	HVNL
Load-carrying vehicle	In the context of a Class 1 heavy vehicle, this is a heavy vehicle carrying, or designed for the purpose of carrying, a large indivisible item, including, for example, a combination including a low loader. Generally speaking, a heavy vehicle that carries a load of some description.	HV(MDL) NR

Load restraint guide	A document of that name prepared by the National Transport Commission and published in the Commonwealth Gazette, from time to time.	HVNL
Loaded mass	The vehicle's mass together with the mass of the vehicle's load that is transmitted to the ground.	HVNL
Local government authority	For a participating jurisdiction, means an entity that is declared by a law of that jurisdiction to be a local government authority for that jurisdiction for the purposes of the HVNL.	
Low loader	A trailer with a loading deck no more than 1 metre above the ground.	HVNL
M		
Maintenance management accreditation (NHVAS)	A management system demonstrating that heavy vehicles are appropriately inspected, serviced, repaired and maintained.	
Mass limits	The maximum allowable mass of an axle or axle group, vehicle or vehicle combination. Common mass limit regimes include general mass limits, concessional mass limits and higher mass limits.	
Mass management accreditation (NHVAS)	A management system demonstrating that the legal mass of heavy vehicles is appropriately controlled for both axle mass and gross mass.	
Mass or dimension authority	1. a mass or dimension exemption; or 2. a Class 2 heavy vehicle authorisation.	HVNL
Mass or dimension exemption	1. a mass or dimension exemption (notice); or 2. a mass or dimension exemption (permit).	HVNL
MDL	1. Mass, Dimension and Loading – as in the HV(MDL)NR. 2. Mass, Distance, Location – as in a potential user-pays road pricing scheme .	
Measurement adjustment	An adjustment applied to the measured mass or measured dimension of a vehicle or vehicle combination in determining compliance with the relevant mass or dimension requirements.	
Measured dimension	The length, width or height of a heavy vehicle or combination and/or its load as displayed on the measuring equipment.	
Measured mass	The mass of an axle or axle group, heavy vehicle or combination as displayed on the weighing equipment.	
Mobile crane	A heavy motor vehicle that is: <ol style="list-style-type: none"> 1. equipped with a crane or other lifting device; and 2. designed primarily for raising, moving and lowering a freely suspended load. 	National class 1 SPV notice

Mobile concrete pump	See Concrete pump .	
Modification	Of a heavy vehicle, means <ol style="list-style-type: none"> the addition of a component to, or the removal of a component from the vehicle, or a change to the vehicle from the manufacturer's specification for the vehicle, but does not include a modification to the vehicle that has been approved under the <i>Motor Vehicle Standards Act 1989</i> of the Commonwealth. 	HVNL
Motor vehicle	A vehicle built to be propelled by a motor that forms part of the vehicle.	HVNL
Multi-combination vehicles	All articulated combinations of vehicles with two or more trailers generally exceeding 19.0 metres in length or 42.5 tonnes GCM, including B-doubles and road trains.	
N		
National data strategy (NDS)	A strategy that will define the rules around data collection and usage and may include privacy, access, quality and audit requirements for example.	
National Exchange of Vehicle and Driver Information System (NEVDIS)	Provides all Australian road agencies with access to national vehicle registration and driver licensing information, and assists in reducing licence fraud, vehicle theft and vehicle fraud.	
National Heavy Vehicle Regulator (NHVR)	The independent body established under the Heavy Vehicle National Law to administer that law.	
National Heavy Vehicle Accreditation Scheme (NHVAS)	NHVAS is voluntary and open to operators who can demonstrate a record of compliance with heavy vehicle regulation and standards. Operators can apply for accreditation under the following NHVAS modules: <ul style="list-style-type: none"> Mass Management Maintenance Management Basic Fatigue Management (BFM) Advanced Fatigue Management (AFM) <p>To be eligible for accreditation under NHVAS, operators must agree to abide by the NHVAS standards and business rules and provide documentary and audit evidence that they comply with the relevant NHVAS standards.</p> <p>The maximum period for which the Regulator may grant heavy vehicle accreditation is 3 years.</p>	
NHVAS Approved Auditor	A person registered with the NHVR to conduct NHVAS audits and meets certain criteria. A list of NHVAS Approved Auditors is located on the NHVR website.	
NHVAS Audit Framework	NHVAS Approved Auditors conduct on-site auditing of operators seeking accreditation or who are currently accredited under the NHVAS.	
NHVAS Audit Framework	The framework provides NHVAS Approved Auditors with guidance on the principles, processes and audit methodology that comprise the NHVAS audit system. The purpose of the framework is to provide NHVAS Approved Auditors with a basis for consistent decision making in the tasks requiring judgement during the NHVAS audit process.	
NHVAS Audit Summary Report	A critical document that verifies whether the operator is compliant or non-compliant with the standards of the particular accreditation module. It records the outcome of the audit findings based on evidence gathered and recorded in the relevant Audit Matrix . The NHVAS Approved Auditor provides the final NHVAS Audit Summary Report to the operator and the operator submits to the NHVR with the appropriate application.	
National Transport Commission (NTC)	The entity established by the <i>National Transport Commission Act 2003</i> of the Commonwealth.	HVNL
Network	It is an inter-governmental agency charged with improving the productivity, safety and environmental performance of Australia's road, rail and intermodal transport system (see www.ntc.gov.au).	
Network	A connected system of roads and infrastructure that heavy vehicles can travel on. Can be restricted to a certain class(es) of heavy vehicles.	
Non-standard vehicle	A heavy vehicle that does not comply with prescribed vehicle standards, mass or dimension requirements.	
O		
Operate and operator	A person <i>operates</i> a vehicle or combination, and is an <i>operator</i> of the vehicle or combination, if the person is responsible for controlling or directing the use of— <ul style="list-style-type: none"> for a vehicle (including a vehicle in a combination)—the vehicle; or for a combination—the towing vehicle in the combination. 	HVNL
Over-dimensional vehicle	See Oversize vehicle .	
Overmass vehicle	A heavy vehicle or combination that does not comply with a prescribed mass requirement applying to it (including gross mass, axle or axle group mass).	
Oversize vehicle	A heavy vehicle or combination that does not comply with a prescribed dimension requirement applying to it.	HVNL

Owner	<ol style="list-style-type: none"> Owner of a vehicle means— <ul style="list-style-type: none"> each person who is an owner, joint owner or part owner of the vehicle; or a person who has the use or control of the vehicle under a credit agreement, hiring agreement, hire-purchase agreement or leasing arrangement; or Owner of a combination means— <ul style="list-style-type: none"> each person who is an owner, joint owner or part owner of the towing vehicle in the combination; or a person who has the use or control of the towing vehicle in the combination under a credit agreement, hiring agreement, hire-purchase agreement or leasing arrangement; or Owner of a sample means an owner of the sample or the thing from which it was taken. 	HVNL
OSOM vehicle	<p>Oversize, Overmass vehicles. A heavy vehicle or combination that is oversize and/or overmass (see Oversize vehicle and Overmass vehicle)</p>	
P		
Participating jurisdiction	<ol style="list-style-type: none"> for the HVNL other than Chapter 6 (Driver Fatigue)—means a state or territory in which— <ul style="list-style-type: none"> this Law applies as a law of the state or territory; or a law that substantially corresponds to the provisions of this Law has been enacted; or a law prescribed by the national regulations for the purposes of this subparagraph has been enacted; or for Chapter 6 (Driver Fatigue), means a state or territory in which— <ul style="list-style-type: none"> this Chapter applies as a law of the state or territory; or a law containing provisions that substantially correspond to the provisions of this Chapter is in force. 	HVNL

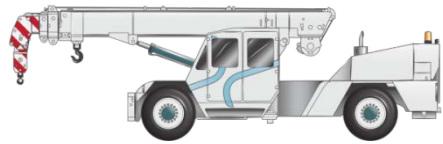
Party in the chain of responsibility	<p>For a heavy vehicle, each of the following persons is a party in the chain of responsibility:</p> <ul style="list-style-type: none"> an employer of the vehicle’s driver if the driver is an employed driver; a prime contractor for the vehicle’s driver if the driver is a self-employed driver; an operator of the vehicle; a scheduler for the vehicle; a loading manager for any goods in the vehicle; a commercial consignor of any goods for transport by the vehicle that are in the vehicle; a consignee of any goods in the vehicle, if Division 4 applies to the consignee. <p>For a fatigue-regulated vehicle, each of the following persons is a party in the chain of responsibility:</p> <ul style="list-style-type: none"> an employer of the vehicle’s driver; a prime contractor for the vehicle’s driver; an operator of the vehicle; a scheduler for the vehicle; a consignor of any goods for transport by the vehicle that are in the vehicle; a consignee of any goods in the vehicle; a loading manager for any goods in the vehicle; a loader of any goods in the vehicle; an unloader of any goods in the vehicle. <p>Note that a person may be a party in the chain of responsibility for a heavy vehicle, or a fatigue-related vehicle in more than 1 capacity.</p>	HVNL
Performance based standards (PBS)	<p>An alternative compliance scheme for heavy vehicles setting minimum performance levels for safe and efficient operation (as opposed to standard prescriptive rules). Greater access is generally afforded for higher performance.</p>	
Period permit	<p>A permit issued for multiple trips on specific routes(s), for a specific vehicle(s) within a time period stipulated in the permit (e.g. three months, one year, three years).</p>	
Pick and carry crane	<p>An articulated mobile crane without stabiliser legs or outriggers which is designed to lift and carry a load.</p> 	National class 1 SPV notice

Pig trailer (also rigid drawbar trailer, drawbar trailer, pony trailer)	<p>A trailer—</p> <ul style="list-style-type: none"> with one axle group or a single axle near the middle of its load carrying surface; and connected to the towing vehicle by a drawbar. 	HVNL
		
Pilot vehicle	<p>A motor vehicle that accompanies an oversize vehicle to warn other road users of the oversize vehicle's presence. (See also Escort vehicle)</p>	HVNL
Pocket road train	<p>A colloquial term used in some jurisdictions to describe a road train, with a shorter overall length, primarily due to shorter trailers and drawbars (typically less than 30 metres).</p>	
Prime mover	<p>A heavy motor vehicle designed to tow a semitrailer.</p>	HVNL
Public safety	<p>The safety of persons or property, including the safety of—</p> <ul style="list-style-type: none"> the drivers of, and passengers and other persons in, vehicles and combinations; and persons or property in or in the vicinity of, or likely to be in or in the vicinity of, road infrastructure and public places; and vehicles and combinations and any loads in them. 	HVNL

Q

Quad-axle group	<p>A group of four axles, in which the horizontal distance between the centre-lines of the outermost axles is more than 3.2m but not more than 4.9m.</p>	HVNL
		

Quarterly compliance statement	<p>An operator's internal record of compliance with the key outcomes of the NHVAS accreditation module. Quarterly compliance statements need to be kept on site and produced on request from a NHVAS Approved Auditor or the NHVR.</p>	
---------------------------------------	--	--

R

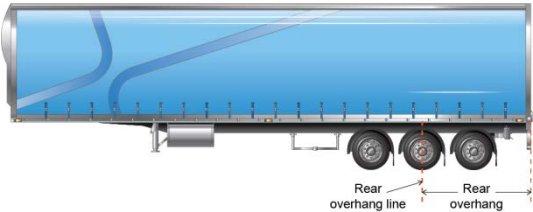
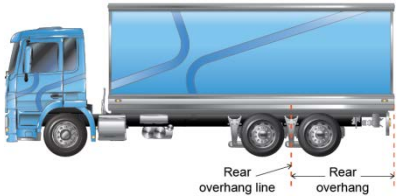

Rear marking plates	<p>Retro-reflective markings fitted to the rear of a heavy vehicle or combination intended to improve the visibility of the vehicle or combination.</p>	
		
	Symbol type plates	Strip type plates

Rear overhang	<p>The distance between the rear of the vehicle and the rear overhang line of the vehicle.</p>	HV(MDL) NR
Relevant vehicle (NHVAS)	<p>A vehicle identified in the relevant management system as currently being operated in accordance with the maintenance management accreditation or mass management accreditation.</p>	HVNL
Rear overhang line	<ol style="list-style-type: none"> For a vehicle with an axle group at the rear comprising only one axle, a (vertical) line running along the centre-line of the axle. For a vehicle with an axle group at the rear comprising two axles, one of which is fitted with twice the number of tyres as the other, the rear overhang line is a line running parallel to the axles that is— <ul style="list-style-type: none"> closer to the axle carrying the greater number of tyres than it is to the other axle; and located at one-third of the distance between the two axles. For a vehicle with an axle group at the rear that is not an axle group mentioned in (1) or (2), the rear overhang line is a line running parallel to the axles down the centre of the axle group. <p>For the purposes of applying subsection (1), (2) or (3) to a vehicle, if an axle group includes at least one steerable axle, that axle is to be disregarded unless—</p> <ul style="list-style-type: none"> the group comprises only one axle and that axle is a steerable axle; or all the axles in the group are steerable axles 	HV(MDL) NR
		
		
Registered operator	<p>Of a heavy vehicle, means the person recorded on the vehicle register as the person responsible for the vehicle.</p>	HVNL
Regulator	<p>See National Heavy Vehicle Regulator.</p>	

Responsible person	For a heavy vehicle means a person having, at a relevant time, a role or responsibilities associated with road transport using the vehicle (including the operator).	HVNL
Restricted access vehicle (RAV)	A vehicle that is not a general access vehicle. RAV is an umbrella term for Class 1, 2 and 3 vehicles and those operating at HML. RAVs operate under a notice or permit issued by or on behalf of the Regulator. Examples are B-doubles, road trains, cranes, etc.	
Reviewable decision	A decision made by the Regulator, an authorised officer, or road manager that may be reviewed. Schedule 3 - Reviewable decisions of the HVNL outlines reviewable decisions made by the Regulator, authorised officers, and road managers.	
Road	For the purposes of the HVNL, a road is an area that is open to or used by the public and is developed for, or has as one of its uses, the driving or riding of motor vehicles.	HVNL
Road authority	The road authority for a participating jurisdiction means an entity that is declared by a law of that jurisdiction to be the road authority for that jurisdiction for the purposes of the HVNL.	HVNL
Road condition	Means a condition directed at— <ul style="list-style-type: none"> protecting road infrastructure; or preventing or minimising an adverse effect on the community arising from noise, emissions or traffic congestion or from other matters stated in approved guidelines; or preventing or minimising significant risk to public safety arising from a heavy vehicle use that is incompatible with road infrastructure or traffic conditions; but does not include a condition requiring the installation of equipment or another thing in a vehicle unless the equipment or thing is required to be installed in the vehicle for an intelligent access condition imposed in connection with a condition directed at the matters mentioned in above points. 	HVNL
Road friendly suspension	A suspension system certified as a road friendly suspension systems by the Vehicle Safety Standards Branch if the Commonwealth Department Infrastructure and Regional Development in accordance with VSB11.	HV(MDL) NR
Road manager	For a road in a participating jurisdiction, means an entity that is declared by a law of that jurisdiction to be the road manager for the road for the purposes of this Law. For a mass or dimension authority, a road manager for a road in the area, or on the route, to which the authority applies. Road managers are defined in the HVNL as it is applied in each jurisdiction i.e. each jurisdiction defines its set of road managers.	HVNL

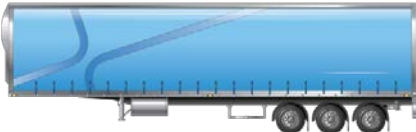
Road train	A B-triple; or A combination, other than a B-double, consisting of a motor vehicle towing at least two trailers, excluding any converter dolly supporting a semitrailer.	HVNL
		
Rolling stock	Rolling stock is a vehicle designed to operate or move on a railway track and includes a locomotive, carriage, rail car, rail motor, light rail vehicle, tram, light inspection vehicle, self-propelled infrastructure maintenance vehicle, trolley, wagon or monorail vehicle. A vehicle designed to operate both on and off a railway track is rolling stock when the vehicle is being— <ul style="list-style-type: none"> operated or moved on a railway track; or maintained, repaired or modified in relation to the operation or movement of the vehicle on a railway track. 	HVNL
Route	A set of connection roads and infrastructure allowing a vehicle to travel from one location to another.	

S		
S-dimension	Sometimes used in the context of trailer wheelbase. See wheelbase .	
Safe location	A location where an authorised officer reasonably believes the heavy vehicle will pose a reduced risk or no appreciable risk of harm to public safety, the environment, road infrastructure or public amenity. Example of a safe location— <ul style="list-style-type: none"> a depot of the heavy vehicle or, if the heavy vehicle is a combination, a depot of a vehicle in the combination a weighbridge a rest area a place where the heavy vehicle can be loaded or unloaded. 	HVNL
Safety risk	A risk— <ul style="list-style-type: none"> to public safety; or of harm to the environment. 	HVNL
Semitrailer	A trailer that has — <ul style="list-style-type: none"> one axle group or a single axle towards the rear; and a means of attachment to a prime mover that results in some of the mass of the trailer's load being imposed on the prime mover. 	HVNL

Sight distance	The distance, measured along the road over which visibility occurs between a driver or rider and an object or between two drivers at specific heights above the carriageway in their lane of travel. There are many specific types of sight distance (e.g. approach sight distance, stopping sight distance)	Austrads Glossary of Terms
Single axle group	A group of two or more axles in which the horizontal distance between the centre-lines of the outermost axles is less than 1m.	HV(MDL) NR
Single trip permit	A permit for a specific vehicle to carry a specific load over a specified route on a specified date (or a single trip within a limited date range).	
Skel-trailer (also skeletal trailer)	A semitrailer or trailer consisting of a bare framework and chassis used primarily for transporting containerised freight.	
Soft copy	An electronic copy of a document.	
Solo driver	A driver who is not a party to a two-up driving arrangement.	HVNL
Special purpose vehicle (SPV)	A motor vehicle or trailer, other than an agricultural vehicle or a tow truck, built for a purpose other than carrying goods; or A concrete pump or fire-engine.	HVNL
		
Stag trailer	A short last trailer in a B-double combination that connects to a fifth wheel on the towing trailer situated under the towing trailer's load-carrying area.	
		
Stopping sight distance (SSD)	The sight distance required by an average driver or rider (car or truck depending on design requirements), travelling at a given speed, to react and stop before striking an object on the road.	Austrads Glossary of Terms

Swept path	The area bounded by lines traced by the extremities of the bodywork of a vehicle or combination while turning.	Austrads Glossary of Terms
-------------------	--	----------------------------

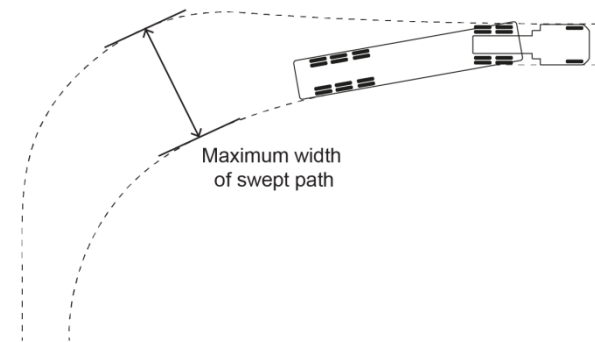

Swept width	The radial distance between the innermost and outermost turning paths of a vehicle or combination.	Austrads Glossary of Terms
--------------------	--	----------------------------

T





Tandem axle group	A group of at least two axles, in which the horizontal distance between the centre-lines of the outermost axles is at least 1m, but not more than 2m.	HVNL
--------------------------	---	------



Tow truck	<ol style="list-style-type: none"> 1. A heavy motor vehicle that is— <ul style="list-style-type: none"> – equipped with a crane, winch, ramp or other lifting device; and – used or intended to be used for the towing of motor vehicles; or 2. A heavy motor vehicle to which is attached, temporarily or otherwise, a trailer or device that is— <ul style="list-style-type: none"> – equipped with a crane, winch, ramp or other lifting device; and – used or intended to be used for the towing of motor vehicles. 	HVNL
------------------	---	------

Tractor	A motor vehicle used for towing purposes, other than— <ul style="list-style-type: none"> • a motor vehicle designed to carry goods or passengers; or • a tow truck See also prime mover.	HVNL
----------------	--	------

Trailer	A vehicle that is built to be towed, or is towed, by a motor vehicle, but does not include a motor vehicle being towed.	HVNL
----------------	---	------

Travel condition	A condition directed at ensuring that access to a stated route or area is limited to either or both of the following— <ul style="list-style-type: none"> stated days or hours (or both); travel in a stated direction. 	HVNL
Tri-axle group	A group of at least three axles, in which the horizontal distance between the centre-lines of the outermost axles is more than 2.0 metres but not more than 3.2 metres.	HVNL
		
Truck	A rigid motor vehicle built mainly as a load carrying vehicle.	HVNL
		
Truck-mounted SPV	An SPV built using an ADR compliant heavy vehicle cab chassis. Most concrete pumps and drilling rigs are truck-mounted SPVs.	National class 1 SPV notice
		
Twinsteer axle group	A group of two axles — <ul style="list-style-type: none"> with single tyres; and fitted to a motor vehicle; and connected to the same steering mechanism; and the horizontal distance between the centre-lines of which is at least 1.0 metre but not more than 2.0 metres. 	HVNL
		
Two-up driving arrangement	An arrangement under which two persons share the driving of a fatigue-regulated heavy vehicle that has an approved sleeper berth.	HVNL
U		
V		
Vehicle	A heavy vehicle or light vehicle.	

Vehicle condition	A condition directed at ensuring a vehicle can operate safely on roads. Note: Vehicle conditions can be imposed by the Regulator or requested by a road manager when authorising access.	
Vehicle unit	See component vehicle .	
W		
Warning sign	A sign indicating that the vehicle to which it is attached is of a particular type, size or configuration.	HVNL
Warning light	A light fitted to a vehicle designed for the specific purpose of warning road users of the vehicle's presence on a road.	HV(VS)NR
Wheelbase	The distance from the centre line of the vehicle's foremost axle to the rear overhang line.	HV(MDL) NR
Work Diary	For the driver of a fatigue-regulated heavy vehicle, generally, means a written work diary or electronic work diary kept by the driver for the purposes of the HVNL.	
X		
Y		
Z		